

Worldwide Sumitomo Network

U.S.A.

Sumitomo Machinery Corporation of America (SMA)
4200 Holland Blvd. Chesapeake, VA 23323, U.S.A.
Tel: (1)757-485-3355
Fax: (1)757-485-7490

Argentina

SM-Cyclo de Argentina S.A. (SMAR)
Montes de Oca #6719, (B1606BMG) Munro,
Buenos Aires, Argentina
Tel: (54)11-4765-5332
Fax: (54)11-4765-5517

Brazil

SM-Cyclo Redutores do Brasil Comercio Ltda. (SMBR)
Av. Fagundes Filho, 191 Metro Sao Judas
Edifício Houston-Sala H123 Sao Paulo-SP
Brasil 04304-010
Tel: (55)11-5585-3600
Fax: (55)11-5585-9990

Chile

SM-Cyclo de Chile, Ltda. (SMCH)
San Pablo N3507, Comuna de Quinta Normal,
Santiago, Chile
Tel: (56)2-892-7000
Fax: (56)2-892-7001

Mexico

SM-Cyclo de Mexico, S.A. de C.V. (SMME)
Calle "C" No. 506A Parque Industrial
Almacentro Apodaca, N. L., Mexico 66600
Tel: (52)81-8144-5130
Fax: (52)81-8369-3699

Canada

SM-Cyclo of Canada, Ltd. (SMC)
1045 South Service Road West, Oakville, Ontario,
Canada L6L 6K3
Tel: (1)905-469-1050
Fax: (1)905-469-1055

Germany

Sumitomo(SHI) Cyclo Drive Germany GmbH (SCG)
Cyclostraße 92, 85229 Markt Indersdorf, Germany
Tel: (49)8136-66-0
Fax: (49)8136-5771

Austria

SCG Branch Austria Office
Gruentalerstraße 30A, 4020 Linz, Austria
Tel: (43)732-330958
Fax: (43)732-331978

Benelux

SCG Branch Benelux Office
Office Heikneuterlaan 23, 3010 Kessel-Lo/Leuven,
Belgium
Tel: (32)16 60 83 11
Fax: (32)16 57 16 39

France

SM-Cyclo France E.U.R.L. (SMFR)
65-75 Avenue Jean Mermoz, Espace Primagaz, 93126
La Courneuve, France
Tel: (33)149-929494
Fax: (33)149-929490

Italy

SM-Cyclo Italy Srl (SMIT)
Via dell' Artigianato 23, 20010 Cornaredo(MI), Italy
Tel: (39)02-9356-2121
Fax: (39)02-9356-9893

Spain

SM-Cyclo Iberia, S.L. (SMIB)
Edificio Gobelás, C/Landabari, nº 4 Escalera 1, 2º Izqda,
Leioa 48940 Vizcaya, Spain
Tel: (34)944-805389
Fax: (34)944-801550

Sweden

SM-Cyclo Scandinavia AB (SMSC)
Ridbanegatan 4, S-21377 Malmö, Sweden
Tel: (46)40220030
Fax: (46)40220035

UK

SM-Cyclo UK Ltd. (SMUK)
Unit 29, Bergen Way, Sutton Fields Industrial Estate,
Kingston upon Hull, HU7 0YQ, East Yorkshire,
United Kingdom
Tel: (44)1482-790340
Fax: (44)1482-790321

China

Sumitomo(SHI) Cyclo Drive China, Ltd. (SCT)
13 Floor, No. 1698 Yishan Rd, Shanghai, China 201103
Tel: (86)21-3462-7877
Fax: (86)21-3462-7922

Hong Kong

SM-Cyclo of Hong Kong Co., Ltd. (SMHK)
Unit 1802, 18/F, Park Building, 476 Castle Peak Road,
Kowloon, Hong Kong
Tel: (852)2460-1881
Fax: (852)2460-1882

Korea

Sumitomo(SHI) Cyclo Drive Korea, Ltd. (SCK)
Office Heikneuterlaan 23, 3010 Kessel-Lo/Leuven,
Belgium
Royal Bldg. 9F Rm. 913, 5 Danju-Dong, Chongro-Gu,
Seoul, Korea 110-721
Tel: (82)2-730-0151
Fax: (82)2-730-0156

Taiwan

Tatung SM-Cyclo Co., Ltd. (TSC)
22 Chungshan N. Road 3rd., Sec. Taipei, Taiwan 104,
R. O. C.
Tel: (886)2-2595-7275
Fax: (886)2-2595-5594

Singapore

Sumitomo(SHI) Cyclo Drive Asia Pacific Pte. Ltd. (SCA)
15 Kwong Min Road, Singapore 628718
Tel: (65)6591-7800
Fax: (65)6863-4238

Philippines

SCA Branch Office in Philippines
B2b Granville Industrial Complex, Governor's Drive, Bo,
Bancaal, Carmona 4116 Cavite, Philippines
Tel: (63)2-6800-6500
Tel: (63)2-6800-6501
Tel: (63)4-6430-3591
Fax: (63)2-6800-6555
Fax: (63)4-6430-3592

Vietnam

SCA Representative Office in Ho Chi Minh
Floor 4, 99 Nguyen Thi Minh Khai Street World Ben Thanh,
District 1, HCM, Vietnam
Tel: (84)8-3925-6504
Fax: (84)8-3925-6505

Malaysia

SM-Cyclo(Malaysia) Sdn. Bhd. (SMMA)
No. 2, Jalan BP 4/1, Bandar Bukit Puchong, 47100
Puchong, Selangor Darul Ehsan, Malaysia
Tel: (60)3-8061-2909
Fax: (60)3-8061-3909

Thailand

SM-Cyclo(Thailand) Co., Ltd. (SMTH)
195, Empire Tower 21st Fl., Unit 2103-4, South
Sathorn Road, Yannawa Sathorn Bangkok 10120,
Thailand
Tel: (66)2-670-0998
Fax: (66)2-670-0999

Australia

SM-Cyclo(Australia) Pty., Ltd. (SMAU)
9 Holbeche Rd, Arndell Park, NSW, 2148, Australia
Tel: (61)2-8811-6555
Fax: (61)2-8811-6500

India

Sumi-Cyclo Drive India Private Limited
Survey No. 130, Hissa No. 02, Jeevan Nagar,
Off Mumbai-Bangalore bypass,
Tathawade, Pune-411 033, India
Tel: (91)20-6674-2900
Fax: (91)20-6674-2901

Japan

Sumitomo Heavy Industries, Ltd.
ThinkPark Tower, 1-1, Osaki 2-Chome,
Shinagawa-ku, Tokyo 141-6025, Japan
Tel: (81) 3-6737-2511
Fax: (81) 3-6866-5160

Sumitomo Drive Technologies

Always on the Move

Motion Control Drives

FINE CYCLO®

F4C-D series



Table of Contents

1. Construction	1
2. Application Examples	3
3. Nomenclature	4
4. Products	4
5. Speed Ratio & Rotation Direction	4
6. Standard Specifications	5
7. Rating	6
8. Engineering Data	10
9. Main Bearings	13
10. Selection	14
11. Notice for Designing	16
12. Outline Drawing	19
13. Operating Principles	22
Warranty Standard	

Motion Control Drives
FINE CYCLO®

F4C-D series

NEW

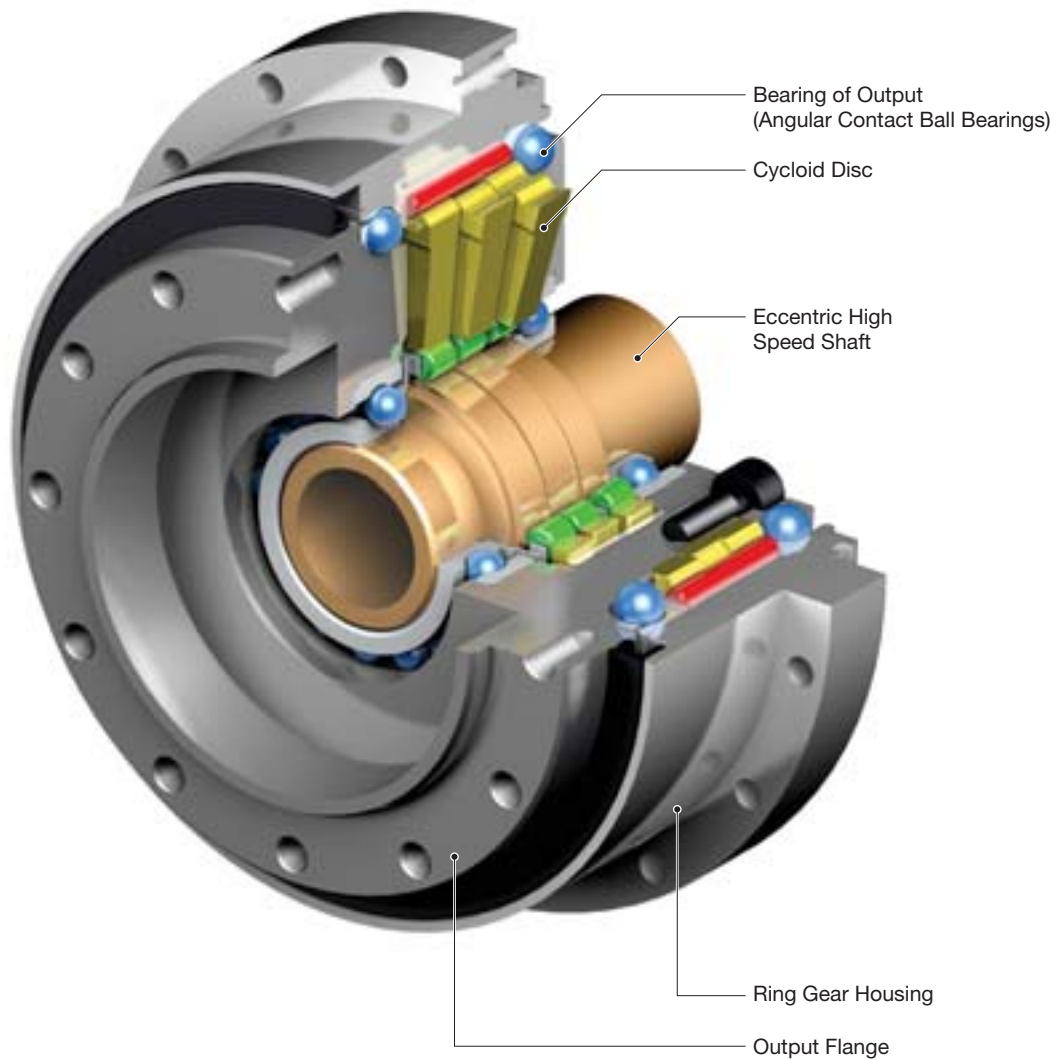

Excellent Cost Performance

Simple construction with less number of parts than single stage reducer mechanism

High Torque, High Allowable Moment Compact design

Allowable peak torque: Maximum 24% increase
Allowable moment: Maximum 45% increase
(Compared to traditional models)

Reduces Man-Hour for Assembly

Flat output flange simplifies sealing process High-speed shaft supported by the reducer simplifies coupling with motor.

New Model Enables Simpler Designing Improved Interface for Coupling Machines

Customer can choose the location of the attachment bolt on the output flange. This was done by the unified construction of the output flange and slow speed shaft pin.

Large Hollow Diameter for the High-Speed Shaft

Reduced Length for Gearmotor Type
Maximum 33% increase compared to the traditional high-speed hollow shaft.

1. Construction

Fig. D-1

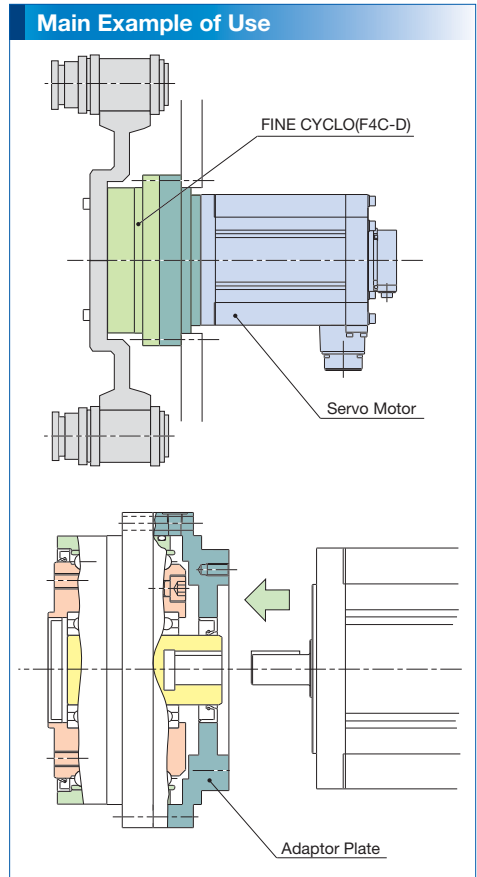
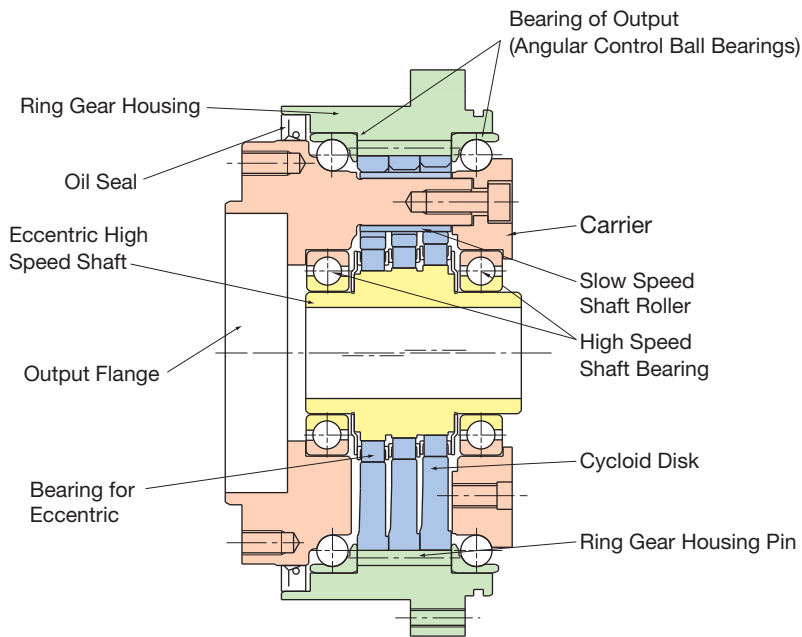

2. Application Examples

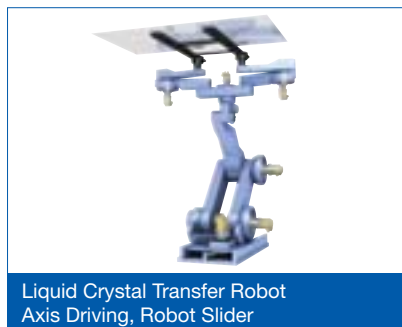
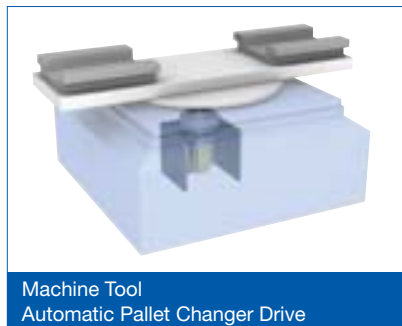

3. Nomenclature

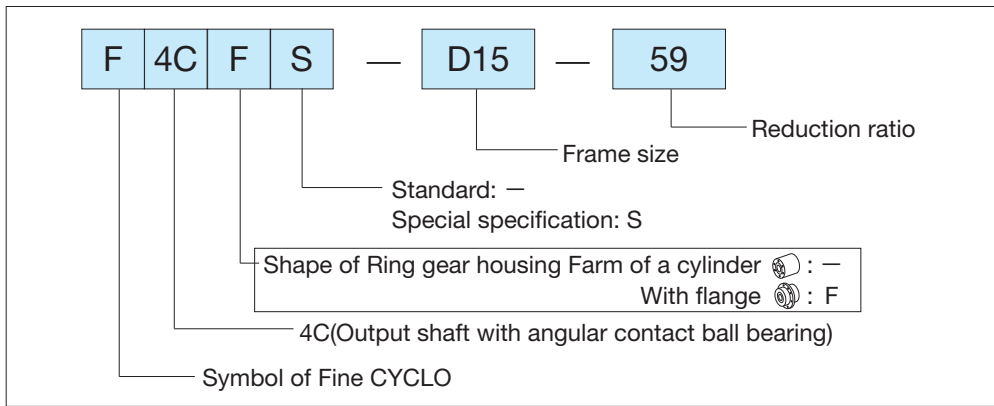

4. Products

Mark ● : Model Lineup

Frame size	Reduction ratio		
	59	89	119
D15	●	●	
D25	●	●	●
D30	●	●	●
D35	●	●	●
D45	●	●	●

5. Speed Ratio & Rotation Direction

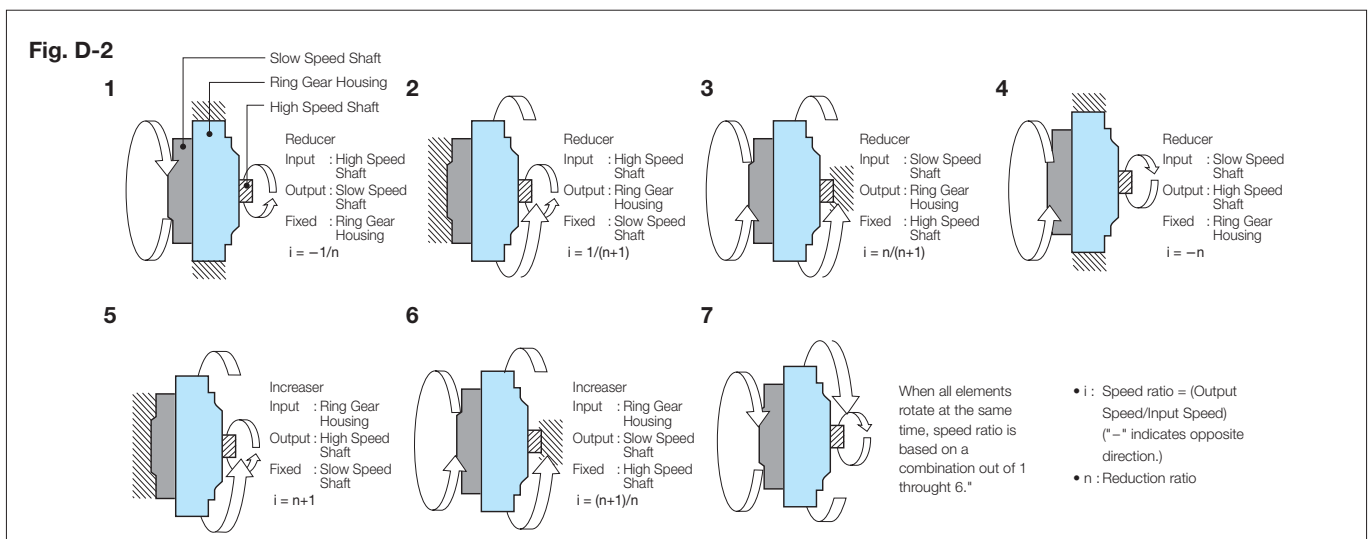

6. Standard Specifications

Lubrication	Grease lubrication The standard units are shipped without grease. Please be sure to fill the unit with the recommended grease. For details, please refer to the chapter of "11-4 Lubrication".	
Ambient conditions	Ambient temperature	-10 to +40°C (There is possibility of malfunctioning startup depending on rotational speed and torque of the motor at -10 to 0°C , please consult us.)
	Ambient humidity	85% max. No condensation.
	Elevation	1000m max.
	Atmosphere	Well ventilated location, free of corrosive gases, explosive gases, vapors and dust.
	Mounting location	Indoor (free from dust, water and other liquids) · Install the units where inspection, maintenance, and other operations can be carried out easily. · Install the unit on a base with sufficient rigidity.
Mounting direction	No limitation, the grease quantity is changed according to the mounting direction. Please fill grease indicated in the chapter of "11-4 Lubrication" as a guide.	
Painting	no painting	

7. Rating

Table D-1 Rating Table (Output rotation base)

Output speed (r/min)		5			10			15			20			25		
Frame size	Reduction ratio	Rated output torque (Upper/N·m) (Lower/kgf·m)	Input speed (r/min)	Allowable input power (kW)	Rated output torque (Upper/N·m) (Lower/kgf·m)	Input speed (r/min)	Allowable input power (kW)	Rated output torque (Upper/N·m) (Lower/kgf·m)	Input speed (r/min)	Allowable input power (kW)	Rated output torque (Upper/N·m) (Lower/kgf·m)	Input speed (r/min)	Allowable input power (kW)	Rated output torque (Upper/N·m) (Lower/kgf·m)	Input speed (r/min)	Allowable input power (kW)
D15	59	226 23.0	295	0.15	226 23.0	590	0.30	201 20.5	885	0.39	184 18.8	1180	0.48	172 17.6	1475	0.56
	89	226 23.0	445	0.15	201 20.5	890	0.26	178 18.1	1335	0.35	163 16.6	1780	0.43	153 15.6	2225	0.50
D25	59	487 49.7	295	0.32	487 49.7	590	0.64	434 44.2	885	0.85	398 40.6	1180	1.04	372 38.0	1475	1.22
	89	487 49.7	445	0.32	433 44.1	890	0.57	383 39.0	1335	0.75	351 35.8	1780	0.92	329 33.5	2225	1.08
	119	487 49.7	595	0.32	396 40.4	1190	0.52	351 35.8	1785	0.69	322 32.8	2380	0.84	301 30.7	2975	0.99
D30	59	635 64.8	295	0.42	635 64.8	590	0.84	566 57.7	885	1.11	519 52.9	1180	1.36	486 49.5	1475	1.59
	89	635 64.8	445	0.42	565 57.6	890	0.74	500 51.0	1335	0.98	459 46.8	1780	1.20	429 43.7	2225	1.40
	119	635 64.8	595	0.42	517 52.7	1190	0.68	458 46.7	1785	0.90	420 42.8	2380	1.10	393 40.1	2975	1.29
D35	59	899 92	295	0.59	899 91.7	590	1.18	800 81.6	885	1.57	734 74.8	1180	1.92	686 70.0	1475	2.25
	89	899 92	445	0.59	798 81.4	890	1.05	707 72.1	1335	1.39	649 66.1	1780	1.70	607 61.8	2225	1.98
	119	899 91.7	595	0.59	732 74.6	1190	0.96	648 66.1	1785	1.27	594 60.6	2380	1.56	556 56.7	2975	1.82
D45	59	1756 179	295	1.15	1756 179	590	2.31	1565 160	885	3.07	1436 146	1180	3.76	1343 137	1475	4.39
	89	1756 179	445	1.15	1562 159	890	2.04	1383 141	1335	2.72	1269 129	1780	3.32	1180 121	2225	3.88
	119	1756 179	595	1.15	1431 146	1190	1.87	1267 129	1785	2.49	1162 118	2380	3.04			

Table D-2 Maximum acceleration or deceleration torque

Frame size	Maximum acceleration or deceleration torque		Peak torque for emergency stop	
	(N · m)	(kgf · m)	(N · m)	(kgf · m)
D15	417	42.5	834	85
D25	883	90	1766	180
D30	1226	125	2453	250
D35	1717	175	3581	365
D45	3188	325	6377	650

30			40			50			60			Allowable maximum input speed (r/min)	Allowable maximum output speed(r/min)		Equivalent On input shaft Upper/Moment of inertia ($\times 10^{-4}$ kg·m ²) Lower/GD ² ($\times 10^{-4}$ kgf·m ²)	Mass (kg)		
Rated output torque (Upper/N·m) (Lower/kgf·m)	Input speed (r/min)	Allowable input power (kW)	Rated output torque (Upper/N·m) (Lower/kgf·m)	Input speed (r/min)	Allowable input power (kW)	Rated output torque (Upper/N·m) (Lower/kgf·m)	Input speed (r/min)	Allowable input power (kW)	Rated output torque (Upper/N·m) (Lower/kgf·m)	Input speed (r/min)	Allowable input power (kW)		50% ED	100% ED				
163 16.6	1770	0.64	150 15.3	2360	0.78	140 14.3	2950	0.92	133 13.5	3540	1.04	6150	5600	2800	0.38	5.2		
145 14.7	2670	0.57	133 13.5	3560	0.69	124 12.6	4450	0.81	117 12.0	5340	0.92				1.52		0.37	1.50
353 35.9	1770	1.38	323 33.0	2360	1.69	302 30.8	2950	1.98	286 29.2	3540	2.25	5050	4200	2100	1.55	8.1		
311 31.7	2670	1.22	285 29.1	3560	1.49										1.54		6.15	
285 29.1	3570	1.12													1.53		6.12	
460 46.9	1770	1.81	422 43.0	2360	2.21	394 40.2	2950	2.58	373 38.1	3540	2.93	4550	3800	1900	3.99	11		
406 41.4	2670	1.59	373 38.0	3560	1.95										3.96		15.85	
372 37.9	3570	1.46													3.95		15.81	
650 66.2	1770	2.55	596 60.8	2360	3.12	557 56.8	2950	3.65				3950	3300	1650	4.93	15		
574 58.5	2670	2.25													4.89		19.55	
															4.87		19.50	
1271 130	1770	4.99	1166 119	2360	6.11							3150	2600	1300	12.51	24		
															50.03		12.41	49.65
															12.38		49.52	

: 50%ED range : 100%ED range

Notes:

- Rated output torque
Rated output torque implies allowable mean load torque at each output speed. Rated output torque for below 600r/min input is the same as 600r/min.
Allowable input power is the value converted from rated output torque, when it is 100%. This value takes efficiency of FINE CYCLO® in consideration.
- Allowable maximum input speed and allowable mean input speed
Reducer may be used within maximum input speed indicated in the Table, however, allowable mean input speed is limited by operation (%ED).
- Allowable acceleration or deceleration peak torque
Allowable peak torque at normal start and stop.
- Allowable momentary maximum torque
Allowable momentary maximum torque at emergency stop or heavy shock, when loading 1000 times in overall lifetime.
- Moment of inertia, GD²
Value at input shaft. Divide them by g (Moment of inertia: 9.8m/sec²) or 4g (GD²: 4 x 9.8m/sec²) to convert from them to inertia.
- Calculate the rated torque using the following formula when the speed is not shown in the table above.

$$T_N = T_{15} \left(\frac{15}{N} \right)^{0.3}$$

T_N : Rated torque when output speed N
T₁₅: Rated torque when output speed is 15r/min

Table D-3 Rating Table (Input rotation base)

Input speed (r/min)		4000			3000			2500			2000			1750		
Frame size	Reduction ratio	Rated output torque (Upper/N·m) (Lower/kgf·m)	Output speed (r/min)	Allowable input power (kW)	Rated output torque (Upper/N·m) (Lower/kgf·m)	Output speed (r/min)	Allowable input power (kW)	Rated output torque (Upper/N·m) (Lower/kgf·m)	Output speed (r/min)	Allowable input power (kW)	Rated output torque (Upper/N·m) (Lower/kgf·m)	Output speed (r/min)	Allowable input power (kW)	Rated output torque (Upper/N·m) (Lower/kgf·m)	Output speed (r/min)	Allowable input power (kW)
D15	59	128 13.0	67.8	1.13	139 14.2	50.8	0.93	147 15.0	42.4	0.82	157 16.1	a33.9	0.70	164 16.7	29.7	0.64
	89	128 13.0	44.9	0.75	139 14.2	33.7	0.61	147 15.0	28.1	0.54	157 16.1	22.5	0.46	164 16.7	19.7	0.42
D25	59	275 28.1	67.8	2.44	300 30.6	50.8	2.00	317 32.4	42.4	1.76	339 34.6	33.9	1.50	353 36.0	29.7	1.37
	89	275 28.1	44.9	1.62	300 30.6	33.7	1.32	317 32.4	28.1	1.16	339 34.6	22.5	1.00	353 36.0	19.7	0.91
	119	275 28.1	33.6	1.21	300 30.6	25.2	0.99	317 32.4	21.0	0.87	339 34.6	16.8	0.75	353 36.0	14.7	0.68
D30	59				392 40.0	50.8	2.61	414 42.3	42.4	2.30	443 45.2	33.9	1.96	461 47.0	29.7	1.79
	89				392 40.0	33.7	1.73	414 42.3	28.1	1.52	443 45.2	22.5	1.30	461 47.0	19.7	1.19
	119				392 40.0	25.2	1.29	414 42.3	21.0	1.14	443 45.2	16.8	0.97	461 47.0	14.7	0.89
D35	59				554 56.6	50.8	3.69	586 59.8	42.4	3.25	626 63.9	33.9	2.78	652 66.5	29.7	2.53
	89				554 56.6	33.7	2.44	589 59.8	28.1	2.15	626 63.9	22.5	1.84	652 66.5	19.7	1.68
	119							589 59.8	21.0	1.61	626 63.9	16.8	1.38	652 66.5	14.7	1.25
D45	59							1145 117	42.4	6.35	1224 125	33.9	5.43	1274 130	29.7	4.94
	89							1145 117	28.1	4.21	1224 125	22.5	3.60	1274 130	19.7	3.28
	119							1145 117	21.0	3.15	1224 125	16.8	2.69	1274 130	14.7	2.45

Table D-2 Maximum acceleration or deceleration torque

Frame size	Maximum acceleration or deceleration torque		Peak torque for emergency stop	
	(N·m)	(kgf·m)	(N·m)	(kgf·m)
D15	417	42.5	834	85
D25	883	90	1766	180
D30	1226	125	2453	250
D35	1717	175	3581	365
D45	3188	325	6377	650

1500			1000			750			600			Allowable maximum input speed (r/min)	Allowable maximum input speed(r/min)		Equivalent On input shaft Upper/Moment of inertia (× 10 ⁻⁴ kg·m ²) Lower/GD ² (× 10 ⁻⁴ kgf·m ²)	Mass (kg)
Rated output torque (Upper/N·m) (Lower/kgf·m)	Output speed (r/min)	Allowable input power (kW)	Rated output torque (Upper/N·m) (Lower/kgf·m)	Output speed (r/min)	Allowable input power (kW)	Rated output torque (Upper/N·m) (Lower/kgf·m)	Output speed (r/min)	Allowable input power (kW)	Rated output torque (Upper/N·m) (Lower/kgf·m)	Output speed (r/min)	Allowable input power (kW)		50% ED	100% ED		
171 17.5	25.4	0.57	194 19.8	16.9	0.43	211 21.5	12.7	0.35	226 23.0	10.2	0.30	6150	5600	2800	0.38	5.2
171 17.5	16.9	0.38	194 19.8	11.2	0.28	211 21.5	8.43	0.23	226 23.0	6.74	0.20				0.37	
370 37.7	25.4	1.23	418 42.6	16.9	0.93	455 46.5	12.7	0.76	487 49.7	10.2	0.65	5050	4200	2100	1.55	8.1
370 37.7	16.9	0.81	418 42.6	11.2	0.61	455 46.5	8.43	0.50	487 49.7	6.74	0.43				1.54	
370 37.7	12.6	0.61	418 42.6	8.4	0.46	455 46.5	6.30	0.38	487 49.7	5.04	0.32				1.53	
483 49.3	25.4	1.61	545 55.6	16.9	1.21	594 60.6	12.7	0.99	635 64.8	10.2	0.85	4550	3800	1900	3.99	11
483 49.3	16.9	1.06	545 55.6	11.2	0.80	594 60.6	8.43	0.66	635 64.8	6.74	0.56				3.96	
483 49.3	12.6	0.80	545 55.6	8.4	0.60	594 60.6	6.30	0.49	635 64.8	5.04	0.42				3.95	
683 69.7	25.4	2.27	771 78.7	16.9	1.71	840 85.8	12.7	1.40	899 91.7	10.2	1.20	3950	3300	1650	4.93	15
683 69.7	16.9	1.50	771 78.8	11.2	1.13	840 85.8	8.43	0.93	899 91.7	6.74	0.79				4.89	
683 69.7	12.6	1.13	771 78.6	8.40	0.85	840 85.8	6.30	0.69	899 91.7	5.04	0.59				4.87	
1334 136	25.4	4.44	1507 154	16.9	3.34	1643 168	12.7	2.73	1756 179	10.2	2.34	3150	2600	1300	12.51	24
1334 136	16.9	2.94	1507 154	11.2	2.22	1643 168	8.43	1.81	1756 179	6.74	1.55				12.41	
1334 136	12.6	2.20	1507 154	8.40	1.66	1643 168	6.30	1.35	1756 179	5.04	1.16				12.38	

□ : 50%ED range □ : 100%ED range

Notes:

- Rated output torque
Rated output torque implies allowable mean load torque at each output speed. Rated output torque for below 600r/min input is the same as 600r/min.
Allowable input power is the value converted from rated output torque, when it is 100%. This value takes efficiency of FINE CYCLO® in consideration.
- Allowable maximum input speed and allowable mean input speed
Reducer may be used within maximum input speed indicated in the Table, however, allowable mean input speed is limited by operation (%ED).
- Allowable acceleration or deceleration peak torque
Allowable peak torque at normal start and stop.
- Allowable momentary maximum torque
Allowable momentary maximum torque at emergency stop or heavy shock, when loading 1000 times in overall lifetime.
- Moment of inertia, GD²
Value at input shaft. Divide them by g (Moment of inertia: 9.8m/sec²) or 4g (GD²: 4 × 9.8m/sec²) to convert from them to inertia.
- Calculate the rated torque using the following formula when the speed is not shown in the table above.

$$T_N = T_{1750} \left(\frac{1750}{N} \right)^{0.3}$$

T_N : Rated torque when output speed N
T₁₇₅₀: Rated torque when output speed is 1750r/min

8. Engineering Data

8-1. Stiffness and lost motion

- Hysteresis curve : Relationship between load and displacement of output flange (rotational angle) when load is removed slowly from allowable torque to zero torque, with fixed input shaft.
- Lost Motion : Torsional deflected angle at ± 3% of allowable output torque.
- Stiffness : Slope of the straight line connecting two points, when allowable torque is 50% and 100% on the hysteresis curve.

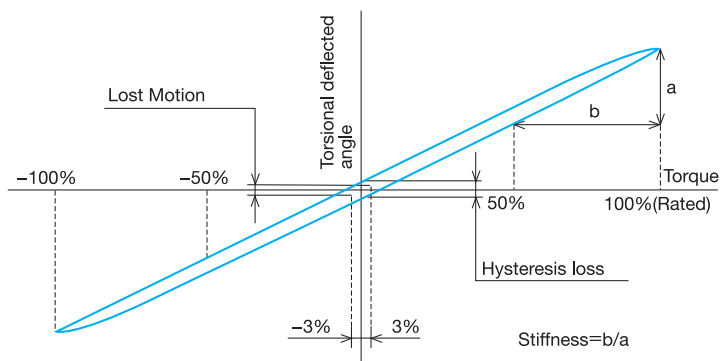

Fig. D-7 Hysteresis curve

8-2. No Load Running Torque

No load running torque indicates torque on input shaft for rotating reducer under no-load condition.

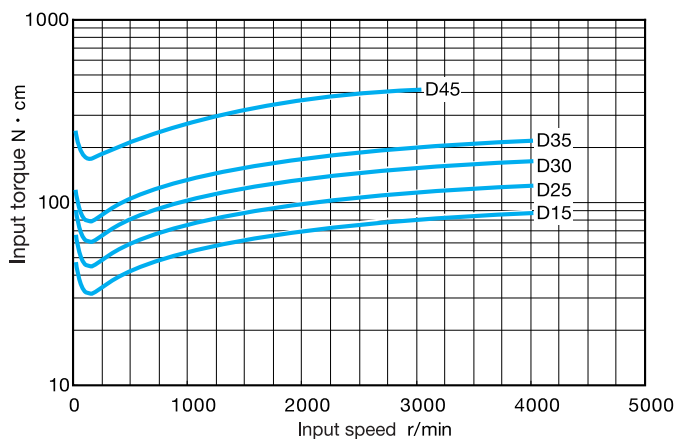

Fig. D-8

- Notes) 1. Fig. D-8 shows average data after reducers have been run.
2. Measurement Conditions

Ring gear housing temperature	Approx. 30°C
Accuracy in assembled dimensions	Refer to 11.1
Lubrication	Standard grease

Table D-4 Engineering data

Frame size	Rated output torque	Lost Motion		Stiffness Up : N/m/arc min Down : kgf·m/arc min
		Measured torque (±) Up/ N·m Down/ kgf·m	Lost Motion arc min	
D15	59	6.03 0.62	1.0	49.0 5.0
	89	5.34 0.54		
D25	59	13.0 1.33		112 11.4
	89	11.5 1.17		
	119	10.5 1.07		
D30	59	17.0 1.73		173 17.7
	89	15.0 1.53		
	119	13.7 1.40		
D35	59	24.0 2.45		220 22.4
	89	21.2 2.16		
	119	19.4 1.98		
D45	59	47.0 4.79		450 45.9
	89	41.5 4.23		
	119	38.0 3.88		

Note) Arc min means "minute" of the angle. Stiffness is the average value (typical data).

(Example calculation of torsional deflected angle)

Calculation of torsion angle when torque is applied in one direction using D35-59 as example.

1) When load torque is 15N·m
(When load torque is in the range of lost motion)

$$\theta = \frac{15}{24} \times \frac{1}{2} = 0.31 \text{ arcmin}$$

2) When load torque is 600N·m

$$\theta = \frac{1}{2} + \frac{600 - 24}{220} = 3.1 \text{ arcmin}$$

8-3. No-Load Friction Torque on Output Shaft

Indicates torque necessary to start rotation from output side of reducer from stop without load.

Table D-5 Value of no-load friction torque on output shaft

Frame size	No-load friction torque on output shaft	
	N·m	kgf·m
D15	34	3.5
D25	60	6
D30	72	7
D35	88	9
D45	167	17

Notes: 1. Table D-5 shows average data after reducers have been run.
2. Measurement Conditions

Accuracy in assembled dimensions	Refer Item 11-1
Lubrication	Standard grease

8-4. Efficiency

Fig. D-9 Efficiency Curve

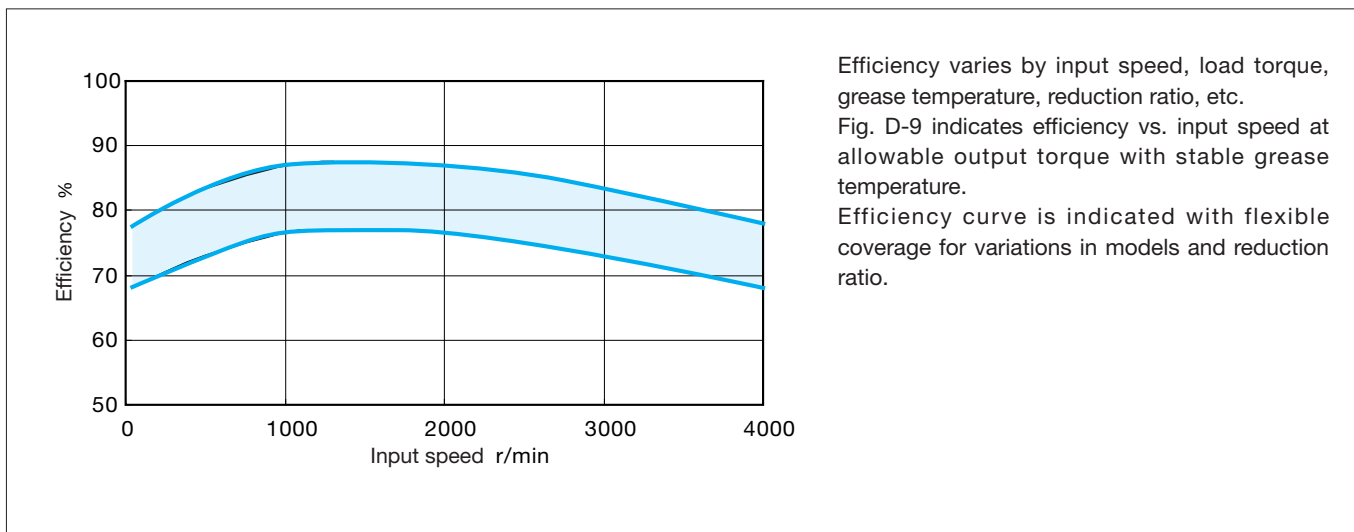
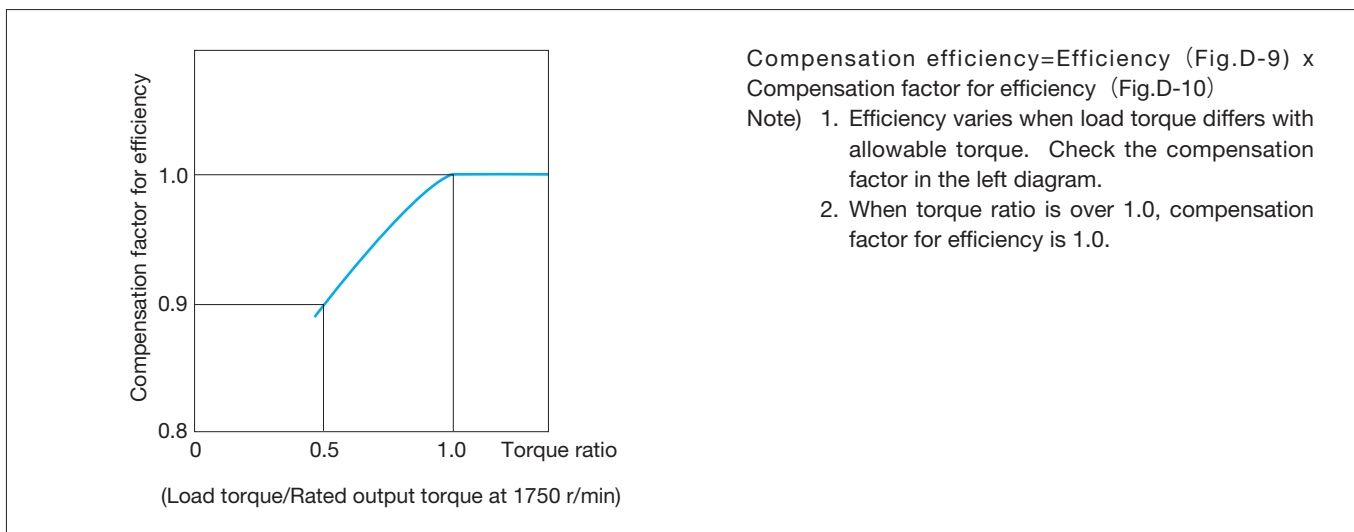

Fig. D-10 Compensation Curve of Efficiency



8-5. ALLOWABLE RADIAL LOAD & AXIAL LOAD OF HIGH SPEED SHAFT

When a gear or sheave is mounted on the high speed shaft, radial load and axial load should be equal to or less than allowable value. Check radial & axial load by following the next formula (①~③).

① Radial load P_r

$$P_r = \frac{T\ell}{R} \leq \frac{P_{ro}}{L_f \cdot C_f \cdot F_{s1}} \quad [\text{N, kgf}] \quad (\text{Formula D-1})$$

② Axial load P_a

$$P_a \leq \frac{P_{ao}}{C_f \cdot F_{s1}} \quad [\text{N, kgf}] \quad (\text{Formula D-2})$$

③ When radial and axial load co-exist

$$\left(\frac{P_r \cdot L_f}{P_{ro}} + \frac{P_a}{P_{ao}} \right) \cdot C_f \cdot F_{s1} \leq 1 \quad (\text{Formula D-3})$$

P_r : Actual radial load [N, kgf]

$T\ell$: Equivalent torque on input shaft [N·m, kgf·m]

R : Pitch circle radius of sprocket, gear, or sheave [m]

P_{ro} : Allowable radial load [N, kgf] (Table D-6)

P_a : Actual axial load [N, kgf]

P_{ao} : Allowable axial load [N, kgf] (Table D-7)

L_f : Load location factor (Table D-8)

C_f : Coupling factor (Table D-9)

F_{s1} : Shock factor (Table D-10)

Table D-6 Actual radial load P_{ro} (Up: N/Down: kgf)

Frame size	Input speed r/min									
	4000	3000	2500	2000	1750	1500	1000	750	600	
D15	226	245	265	284	294	314	353	392	422	
	23	25	27	29	30	32	36	40	43	
D25	334	373	392	422	441	461	530	589	628	
	34	38	40	43	45	47	54	60	64	
D30		432	461	500	520	549	628	687	746	
		44	47	51	53	56	64	70	76	
D35		491	520	559	589	618	706	785	844	
		50	53	57	60	63	72	80	86	
D45			608	657	687	726	824	912	981	
			62	67	70	74	84	93	100	

Calculate the actual radial load using the following formula when the speed is not shown in the table above.

$$P_{rN} = P_{r1750} \left(\frac{1750}{N} \right)^{1/3}$$

P_{rN} : Actual radial load when input speed N

P_{r1750} : Actual radial load when input speed 1750r/min

Table D-7 Actual axial load P_{ao} (Up: N/Down: kgf)

Frame size	Input speed r/min									
	4000	3000	2500	2000	1750	1500	1000	750	600	
D15	245	284	314	343	363	392	471	549	608	
	25	29	32	35	37	40	48	56	62	
D25	363	412	451	500	540	579	697	804	883	
	37	42	46	51	55	59	71	82	90	
D30		520	569	638	677	726	883	1001	1118	
		53	58	65	69	74	90	102	114	
D35		540	589	657	706	755	922	1059	1167	
		55	60	67	72	77	94	108	119	
D45			1010	1118	1197	1295	1570	1795	2001	
			103	114	122	132	160	183	204	

Calculate the actual axial load using the following formula when the speed is not shown in the table above.

$$P_{aN} = P_{a1750} \left(\frac{1750}{N} \right)^{0.47}$$

P_{aN} : Actual axial load when output speed N

P_{a1750} : Actual axial load when output speed 1750r/min

Table D-8 Load Location Factor L_f

L (mm)	Frame size				
	D15	D25	D30	D35	D45
10	0.91	0.87			
15	0.99	0.94	0.92	0.91	
20	1.25	1.00	0.98	0.97	0.90
25	1.56	1.25	1.14	1.09	0.94
30	1.88	1.50	1.36	1.30	0.99
35	2.19	1.75	1.59	1.52	1.13
40		2.00	1.82	1.74	1.29
45			2.05	1.96	1.45
50				2.17	1.61
60					1.94
Lf=When 1 of L(mm)	16	20	22	23	31
a	0.072	0.063	0.061	0.055	0.046

$L \geq L1$ $L_f = L/L1$ $L1$: Lf = When 1 of L

$L < L1$ $L_f = 1.0 - a/5 \times (L1 - L)$

Table D-9 Coupling Factor C_f

Coupling method	C_f
Chain	1
Machine gear or pinion	1.25
Timing belt	1.25
V-Belt	1.5

Table D-10 Shock Factor F_{s1}

Degree of shock	F_{s1}
Practically no shock	1
Light shock	1 ~ 1.2
Severe shock	1.4 ~ 1.6

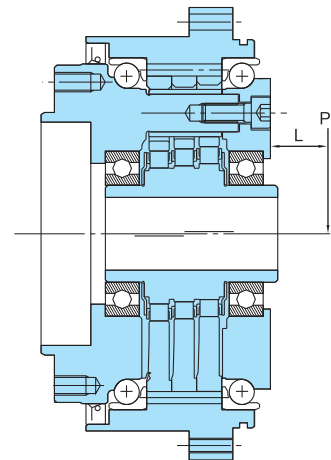

Fig. D-11 Load location on input shaft

9. Main Bearings

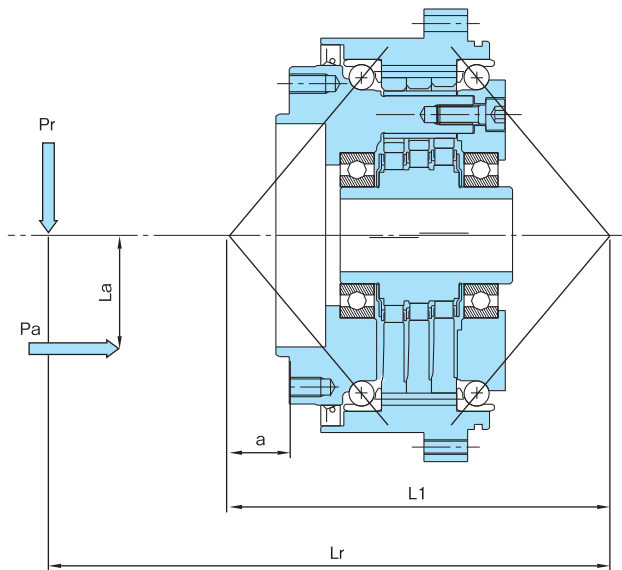

Fig. D-12 Span between each loading point
 Note) Consult us if: $L_r > 4 \times L_1$

P_r : Actual radial load (N, kgf)
 P_a : Actual axial load (N, kgf)

Table D-11 Span of Loading Points (mm)

Frame size	Span of Loading Points	
	L1(mm)	a(mm)
D15	119	23.6
D25	139	23.4
D30	157	24.5
D35	170	40.5
D45	206	52.4

Table D-12 Moment Stiffness

Frame size	Moment Stiffness	
	(N·m/arcmin)	(kgf·m/arcmin)
D15	510	52
D25	833	85
D30	1127	115
D35	1470	150
D45	2450	250

Table D-13 Allowable Moment & Allowable Axial Load

Frame size	Allowable Moment		Allowable Axial Load	
	(N·m)	(kgf·m)	(N)	(kgf)
D15	883	90	3924	400
D25	1177	120	3924	400
D30	1668	170	5199	530
D35	1962	200	7848	800
D45	2943	300	10791	1100

1. Moment Stiffness

Indicates stiffness on inclination of output shaft with external moment.

External moment (M)

$$M = P_r \cdot L_r + P_a \cdot L_a \quad \text{..... (Formula D-4)}$$

2. Allowable Moment & Allowable Axial Load

Check external moment and external axial load with Formula D-5, Formula D-6, and Fig.D-13.

Equivalent moment (M_e)

$$M_e = C_f \cdot F_{S1} \cdot P_r \cdot L_r + C_f \cdot F_{S1} \cdot P_a \cdot L_a \quad \text{..... (Formula D-5)}$$

Equivalent axial load (P_{ae})

$$P_{ae} = C_f \cdot F_{S1} \cdot P_a \quad \text{..... (Formula D-6)}$$

C_f : Coupling factor [Table D-14]

F_{S1} : Shock factor [Table D-15]

Table D-14 Coupling Factor C_f

Load connection factor	C_f
General purpose chain	1
Machine gear or pinion	1.25
Timing belt	1.25
V-Belt	1.5

Table D-15 Shock factor F_{S1}

Load Classification	F_{S1}
Uniform load (no shock)	1
Moderate shocks	1 ~ 1.2
Heavy shocks	1.4 ~ 1.6

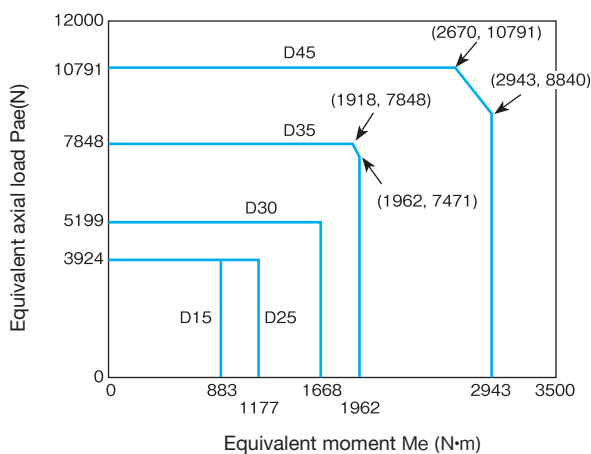
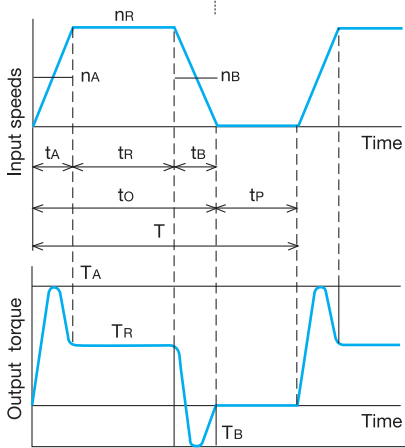

Fig. D-13 Diagram of Allowable Moment & Axial Load

10. Selection

10-1. Flow Cart and Formula of Selection

FIG. D-14 Load cycle



- n_A : Average input speed during acceleration under condition defined in Fig. D-14

$$n_A = \frac{n_R}{2}$$
- n_R : Input speed with normal running
- n_B : Average input speed during deceleration under condition defined in Fig. D-14

$$n_B = \frac{n_R}{2}$$
- t_A : Acceleration time
- t_R : Normal running time
- t_B : Deceleration time
- t_o : Total running time
- t_P : Standstill time
- T : Time/Cycle
- T_A : Acceleration peak torque
- T_R : Torque during normal running
- T_B : Peak torque at braking

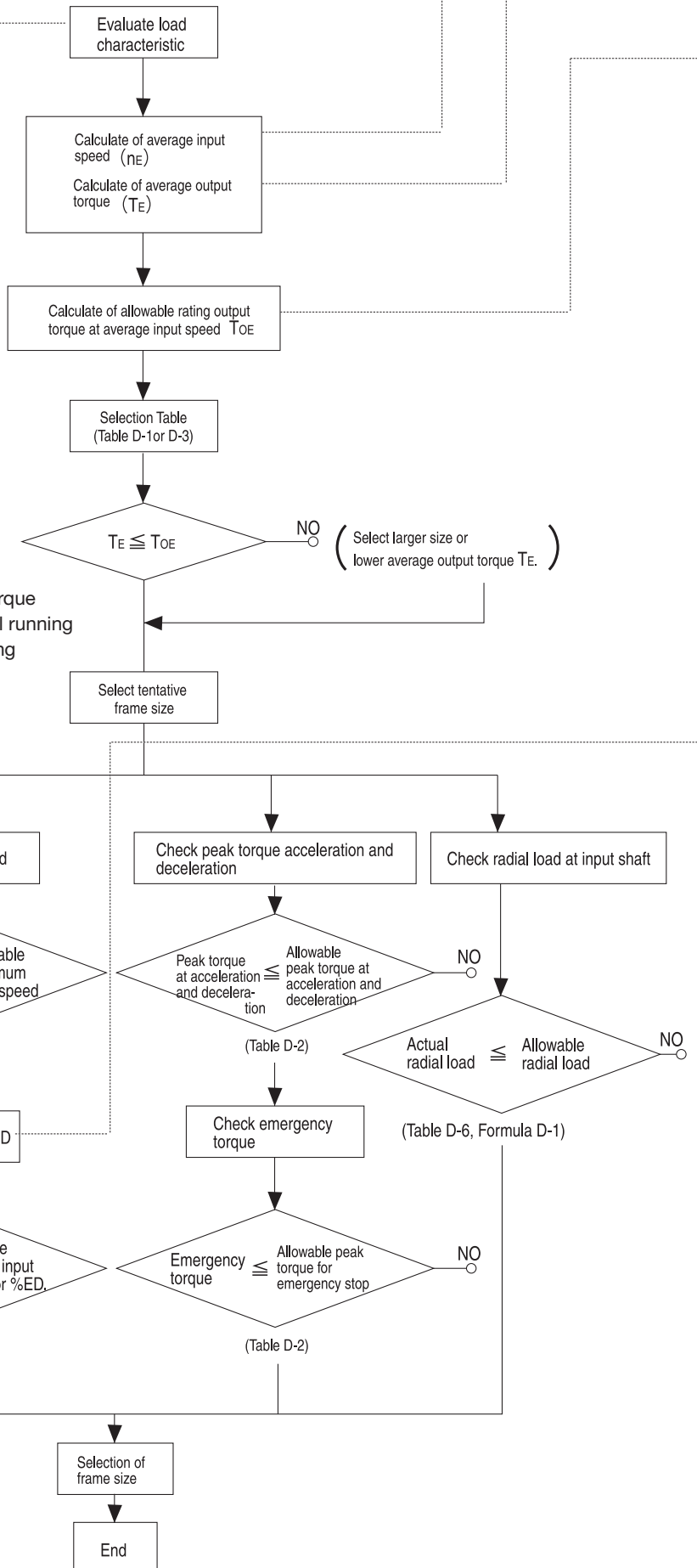

Calculation in Load Condition of Fig. D-14

○ Average input speed $n_E = \left(\frac{t_A n_A + t_R n_R + t_B n_B}{t_o} \right)$ (Formula D-8)

○ Average output torque $T_E = \left(\frac{t_A n_A T_A^{10/3} + t_R n_R T_R^{10/3} + t_B n_B T_B}{t_o} \right)^{0.3} \times F_{S2}$ (Formula D-9)

○ Allowable rating output torque at average input speed $T_{OE} = \left(\frac{600}{n_E} \right)^{0.3} \times T_o$ (Formula D-10)

To: Rated output torque at input speed 600r/min (Table D-3)
When $n_E < 600$, T_{OE} equals to T_o at input speed 600r/min.

○ %ED $\%ED = \frac{t_o}{T} \times 100$ (Formula D-10)

Maximum of single cycle time is 10 minutes when calculating %ED. When single cycle time is over 10 minutes, calculate %ED as T=10 (minutes).

Table D-16 F_{S2} Load factor

Loading condition	F_{S2}
Uniform load	1
Moderate shock	1 ~ 1.2
Heavy shock	1.4 ~ 1.6

10-2. Example of Selection

Evaluate F4CF-D25-119 for following specification.

(Specification) T_A : Acceleration peak torque	600N·m	t_A : Acceleration time	0.3sec
T_R : Normal running torque	250N·m	t_R : Normal running time	3.0sec
T_B : Peak torque at breaking	400N·m	t_B : Deceleration time	0.3sec
Emergency torque : 1700N·m		t_P : Total running time	3.6sec
(1000 times during overall life time)		t_o : Standstill time	3.6sec
n_A : Average input speed during acceleration	1250r/min	T : Single cycle time	7.2sec
n_R : Input speed with normal running	2500r/min	Radial load at input shaft : Operated by timing belt with moderate shock	196N at point 25mm from end of shaft
n_B : Average input speed during deceleration	1250r/min	Radial load at output shaft : Connection with gear, moderate shock	4116N at 60mm point from side of flange

It considered that reducer is used to operate wrist of robot with moderate shock.

(Calculate) Average input speed $n_E = \frac{0.3 \times 1250 + 3.0 \times 2500 + 0.3 \times 1250}{3.6} = 2292(r/min)$

Average output torque $T_E = \left(\frac{0.3 \times 250 \times 600^{10/3} + 3.0 \times 2500 \times 250^{10/3} + 0.3 \times 1250 \times 400^{10/3}}{3.6 \times 2292} \right) \times 1 = 306(N·m)$

○ Allowable output torque at average input speed $T_{OE} = \left(\frac{600}{2292} \right)^{0.3} \times 487 = 326(N·m) \geq 306(N·m) \rightarrow F4CF-D25-119$

○ Calculate of %ED $\%ED = \frac{3.6}{7.2} \times 100 = 50\%$

○ Evaluate of maximum input speed 2500(r/min) < 5050(r/min) (Table D-1 or D-3)

○ Evaluate of average input speed 2292(r/min) at 50% ED < 4200(r/min) at 50% ED (Table D-1 or D-3)

○ Evaluate of peak torque at acceleration and deceleration 600(N·m) < 883(N·m) (Table D-2)

○ Evaluate of emergency torque 1700(N·m) < 1766(N·m)(with dowel pins) (Table D-2)

○ Allowable radial load at input shaft with coefficient in consideration

Pro = 402N = 441 × (1750/2292)^{1/3}, Lf = 1.25, Cf = 1.25, F_{S1} = 1.2

$\frac{Pro}{Lf \times Cf \times F_{S1}} = \frac{420}{1.25 \times 1.25 \times 1.2} = 214(N) > 196(N)$ (Table D-6, Formula D-1)

○ Evaluate of allowable moment

Lr = 55 + L1 - a = 55 + 139 - 23.4 = 175.6

External Moment Calculated with the Coefficient

Cf = 1.25, F_{S1} = 1.2, M = Cf × F_{S1} × Pr × Lr = 1.25 × 1.2 × 4116 × 175.6 = 1084(N·m) < 1177(N·m)

F4CF-D25-119 is selected by evaluation above.

11. Notice for Designing

11-1 Precision in Assembly Dimensions

Fig. D-15 Method of Assembly

- Pilot for mounting input parts(motor etc.) are as (C) in following figure.
- Use (B) for output shaft assembly and (A) for casing assembly as pilot for mounting.

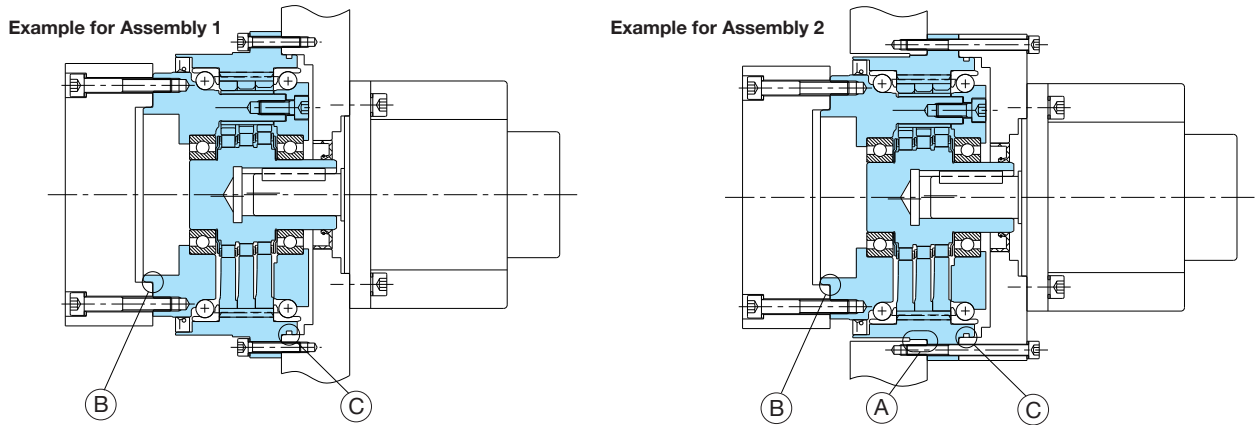
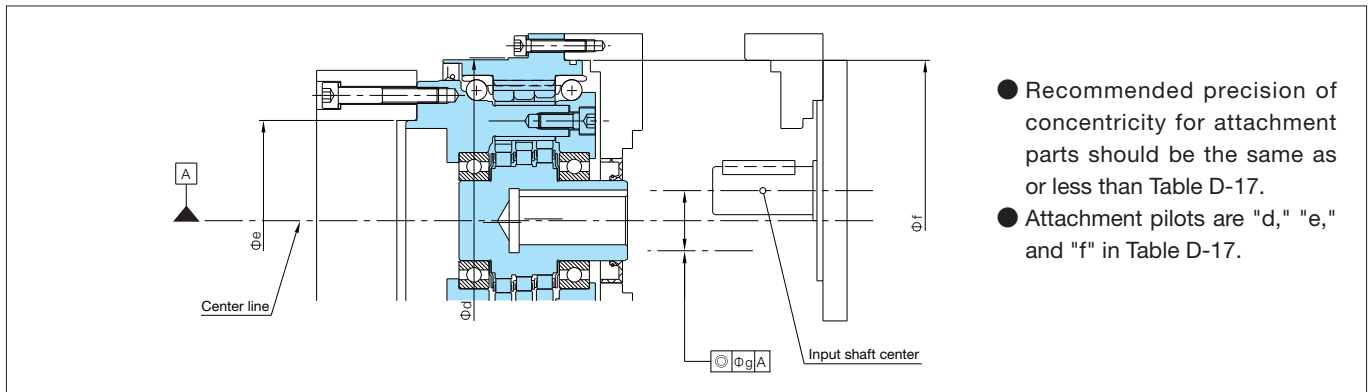

Fig. D-16 Precision in assembly dimensions



- Recommended precision of concentricity for attachment parts should be the same as or less than Table D-17.
- Attachment pilots are "d," "e," and "f" in Table D-17.

Table D-17

Frame size	d	e	f	g
D15	124H7/h7	47H7/h7	123H7/h7	0.03
D25	145H7/h7	80H7/h7	145H7/h7	0.03
D30	163H7/h7	100H7/h7	160H7/h7	0.03
D35	174H7/h7	75H7/h7	174H7/h7	0.03
D45	220H7/h7	100H7/h7	220H7/h7	0.03

11-2. Tightening Torque and Allowable Transmitted Torque for Bolts

(1) Allowable transmitted torque for bolts

Quantity, size, and tightening torque of bolt for the output flange and ring gear housing are shown in Table D-18. Allowable peak torque for emergency stop that can be transmitted is shown in Table D-19.

Table D-18

Frame size	Output Flange Bolts			Ring gear housing bolts		
	Number of bolts-size	Tightening torque		Number of bolts-size	Tightening torque	
		N·m	kgf·cm		N·m	kgf·cm
D15	12—M8	38.3	390	12—M6	15.7	160
D25	12—M8	38.3	390	16—M6	15.7	160
D30	16—M8	38.3	390	16—M6	15.7	160
D35	12—M10	76.5	780	16—M8	38.3	390
D45	16—M12	133	1360	16—M10	76.5	780

Table D-19

Frame size	Allowable transmitted torque by bolts	
	N·m	kgf·m
D15	1478	151
D25	2065	211
D30	2786	284
D35	3962	404
D45	9347	954

- Bolt: Use metric hexagon socket head cap screw based on JIS B1176, strength grade 12.9"
- Countermeasure for bolts loosening: Use adhesives (Loctite262, etc.) or spring washer (based on JIS B1252, class 2).
- Use conical spring washer (Based on JIS B1252, class 2) because the wound dose't put on flange side when coupling the reducer to prevent damaging the bolt bearing surface.

- Friction Coefficient: 0.15

11-3. Assembly Procedure

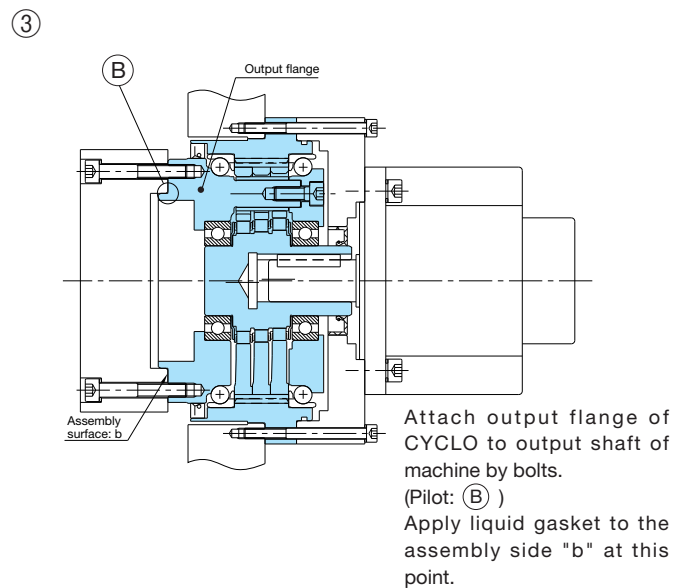
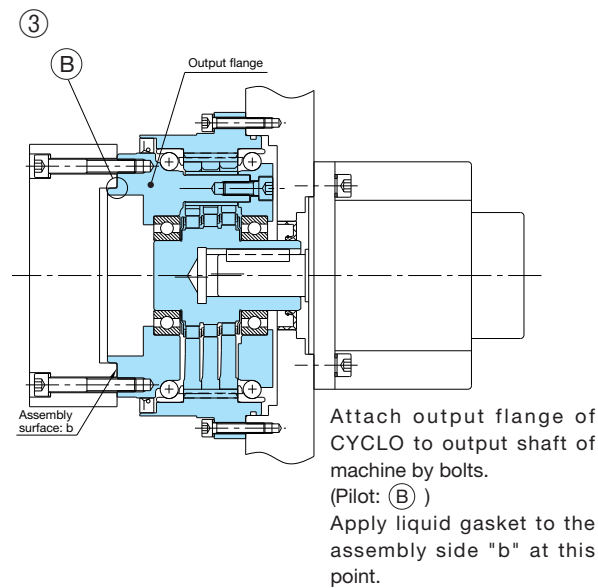
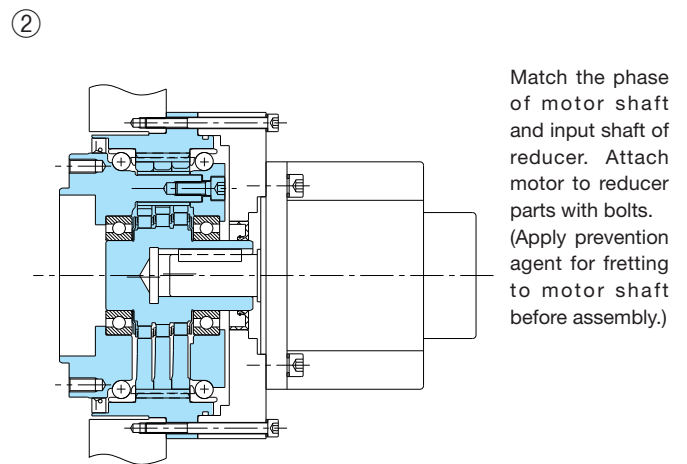
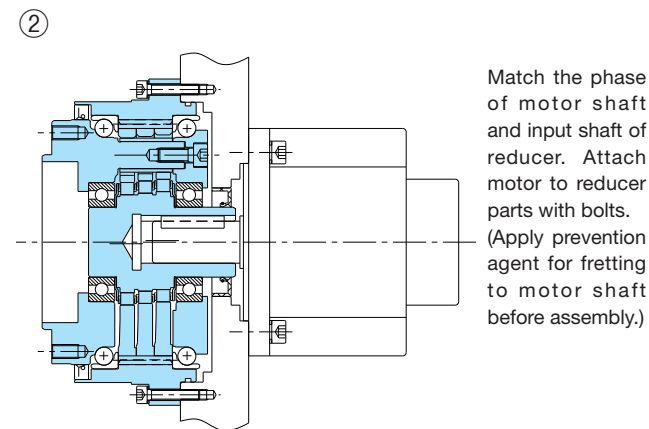
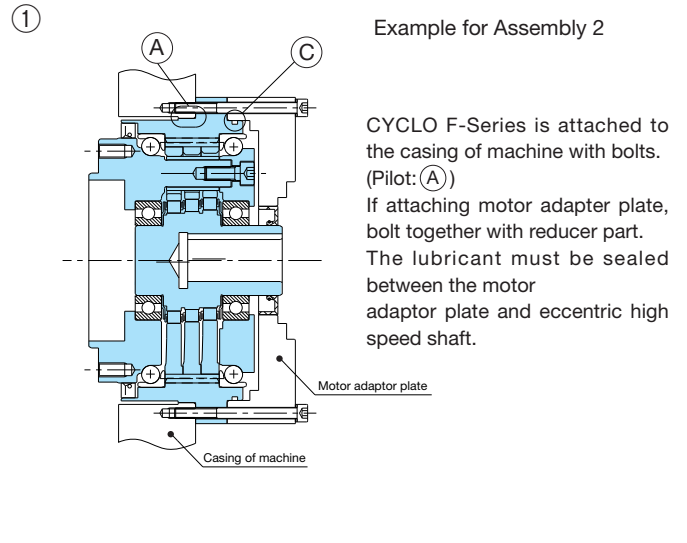
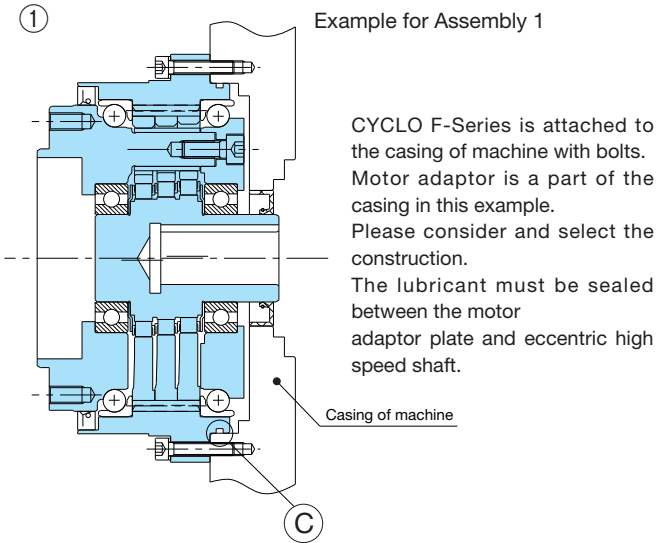

Notes1) Make sure to apply specified tightening torque(refer to Table D-18) to bolts when attaching reducer.
 Notes2) Choose bolts shorter than the depth of tap indicated in output side flange in Outline Drawing (P19-P20), when attaching output shaft to output side flange (slow speed shaft)of CYCLO DRIVE.
 Recommended liquid gasket: Liquid gasket Three Bond 1215 of Three Bond Co., Ltd.

11-4. Lubrication

- F4CF-D-Series are shipped with grease drained at the time of shipment. Customer must prepare and fill appropriate amount of (Table D-20) recommended grease (Table D-21).
- Use quantity indicated in Table D-21 as a guide, check the actual grease level when filling grease.
- Match the position of filler and drain port at output side with one of eccentric planetary shaft bearing. (See ""A"" in Fig.D-17 and Table D-20)"
- When supplying with grease for the first time, fill from lower drain port to ensure grease circulation.
- Change grease every 20,000 hours or every 3 ~ 5 years.

Table D-20 Recommended Grease for F4CF-D Series

Name of recommended	Supplier
Multemp FZ No.00	Kyodo Yushi Co., Ltd.

Ambient Temperature: -10°C ~ 40°C

Table D-21

Frame size	Grease(g)			Position of grease filler port A(mm)
	Vertical (日)	Vertical (月)	Horizontal	
D15	55	40	50	20
D25	100	45	95	26
D30	220	85	200	29
D35	190	150	160	34
D45	320	260	270	39

Fig. D-17

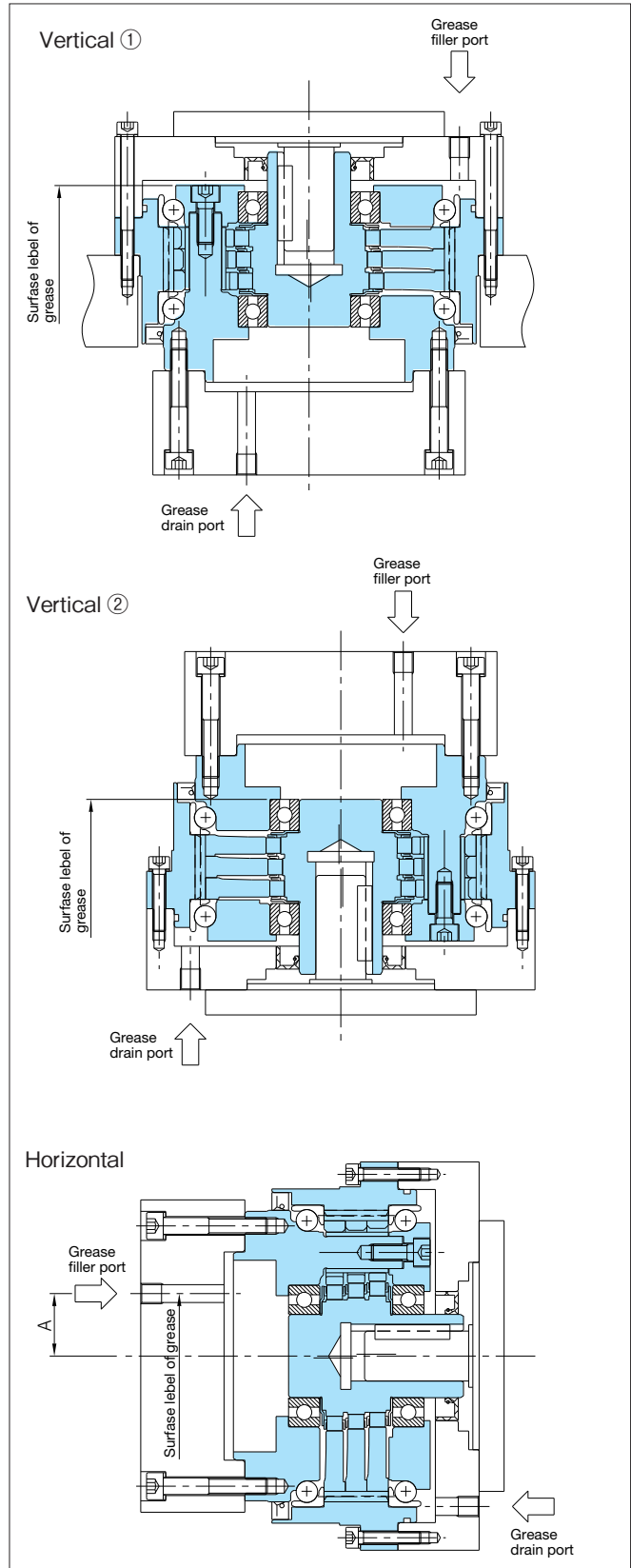

F4CF-D30

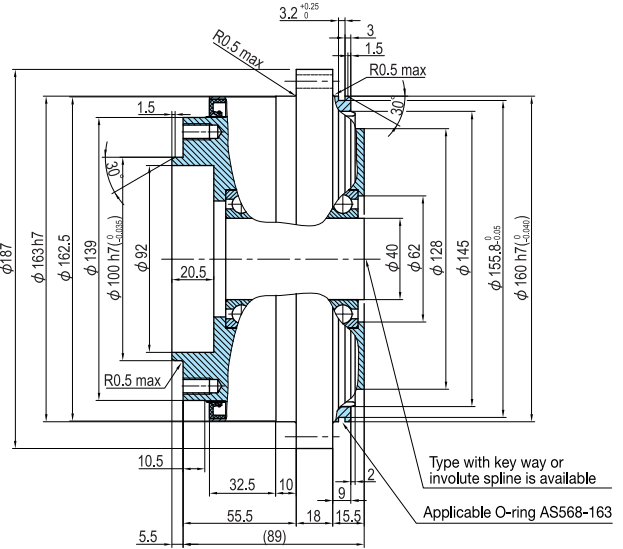
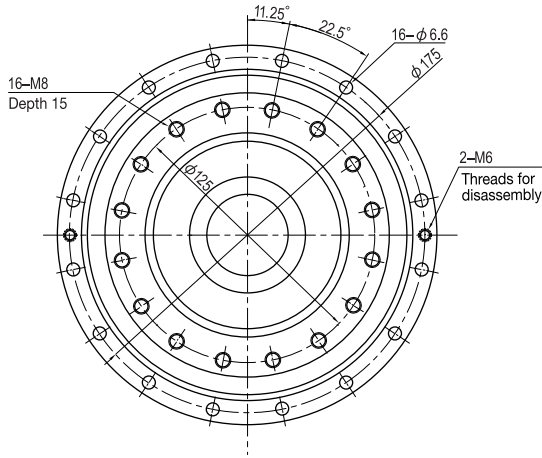

	Maximum diameter of hollow of high-speed shaft
Key method	φ27 (Key 8×7)
Spline method	φ30 (Involute spline 40×30×1.25)

Note: Consult us for the specification of high-speed shaft.

Mass 11kg

F4CF-D35

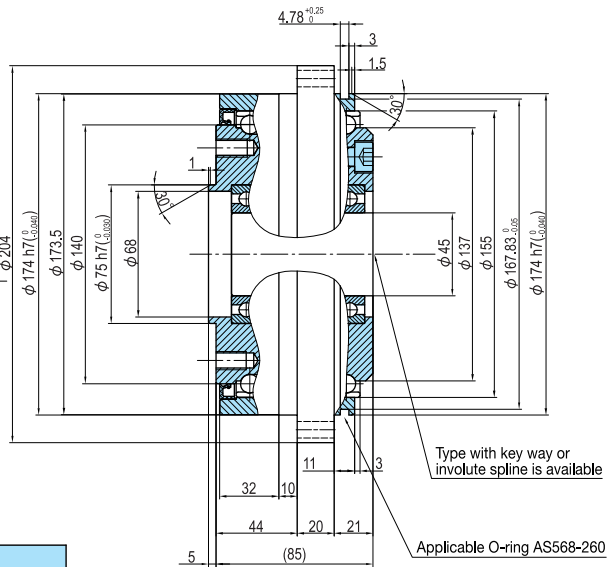
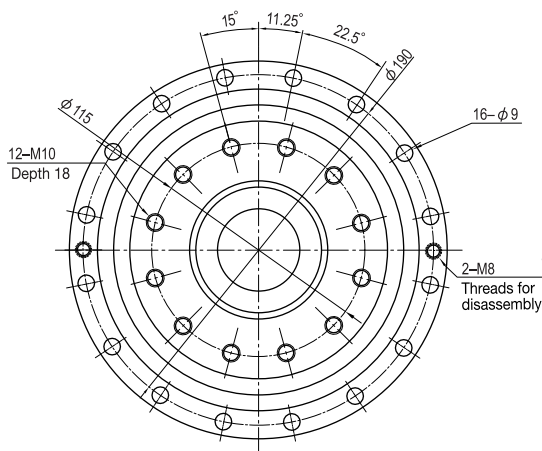

	Maximum diameter of hollow of high-speed shaft
Key method	φ32 (Key 10×8)
Spline method	φ35 (Involute spline 45×25×1.667)

Note: Consult us for the specification of high-speed shaft.

Mass 15kg

F4CF-D45

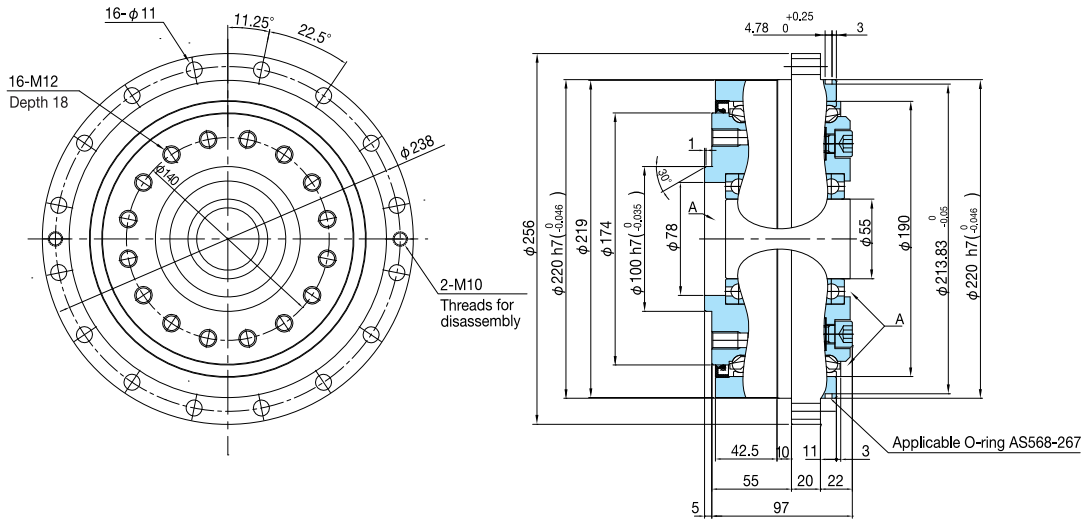

	Maximum diameter of hollow of high-speed shaft
Key method	$\phi 41$ (Key 12×8)
Spline method	$\phi 45$ (Involute spline 55×31×1.667)

Note: Consult us for the specification of high-speed shaft.

Mass 24kg

13. Operating Principles

The reducer portion of the FINE CYCLO® is fundamentally different in principle and mechanism from the involute gearing mechanism of competitive gearmotors. The unique speed reducer portion is an ingenious combination of the following two mechanisms:

- ☆ A combination of a planet gear and a fixed internal sun gear. In the FINE CYCLO®, the planet gear has cycloidal-shaped teeth and the sun gear has circular pin teeth. The number of teeth in the planet gear is one or two less than the sun gear.
- ☆ A constant speed internal gearing mechanism.

Fig. D-3 Principle of internal Planetary Gearing

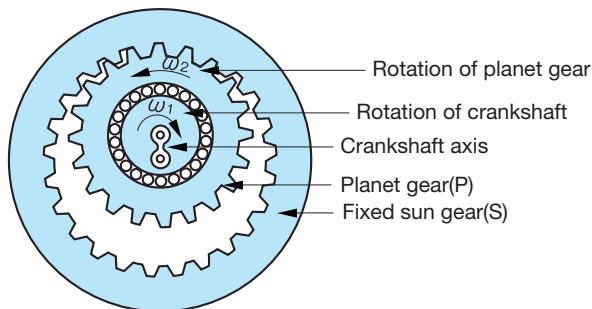

See Fig. D-3

In equation 1, below, P identifies the number of the planet gear teeth, S that of the sun gear, ω_2 the angular velocity of the planet gear around its own axis. The velocity ratio of ω_2 to ω_1 is shown as follows:

$$\frac{\omega_2}{\omega_1} = 1 - \frac{S}{P} = -\frac{S-P}{P} \quad \dots \text{Equation 1}$$

With S greater by one or two than P in this equation, the highest velocity ratio is obtainable.

That is, if $S-P=1$ is applied to Equation 1, the velocity ratio may be calculated from the following equation:

$$\frac{\omega_2}{\omega_1} = \frac{1}{P} \quad \dots \text{Equation 2}$$

Or if $S-P=2$ is applied to Equation 1, the velocity ratio may be calculated from the following equation:

$$\frac{\omega_2}{\omega_1} = \frac{2}{P} \quad \dots \text{Equation 3}$$

As the crankshaft rotates at the angular velocity ω_1 around the axis of the sun gear, the planet gear rotates at the angular velocity:

$$-\frac{1}{P} \omega_1 \quad \text{or} \quad -\frac{2}{P} \omega_1$$

when P indicates the number of the teeth of the planet gear and the symbol indicates that the rotation of the planet gear is in a reverse direction to that of the crankshaft.

In the FINE CYCLO®, illustrated in Fig. D-4, circular teeth(pins) are adapted for the sun gear and epitrochoid curved teeth for the planet gear, thereby avoiding tooth top interference. The rotation of the planet gear around its own axis is taken out through a constant speed internal gearing mechanism as shown in Fig. D-5.

In this mechanism shown in Fig. D-6, the pins of the slow speed shaft are evenly spaced on a circle that is concentric to the axis of the sun gear. The pins transmit the rotation of the planet gear by rolling internally on the circumference of the bores of each planet gear or cycloid disc. The diameter of the bores minus the diameter of the slow speed shaft pins is equal to twice the eccentricity value of the crank shaft (eccentric). This mechanism smoothly transmits only the rotation of the planet gear around its own axis to the slow speed shaft.

Fig. D-4 Epitrochoid Planet Gear-Circular(PIN) Tooth Sun Gear Combination

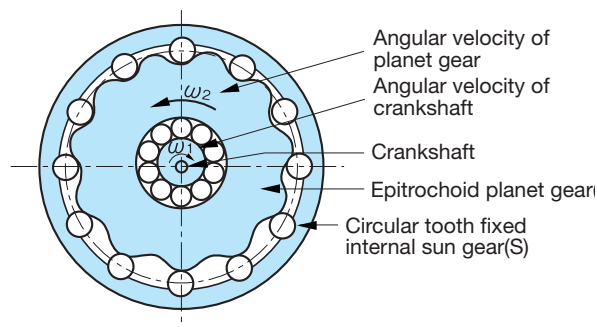

Fig. D-5 Constant Speed Internal Gearing

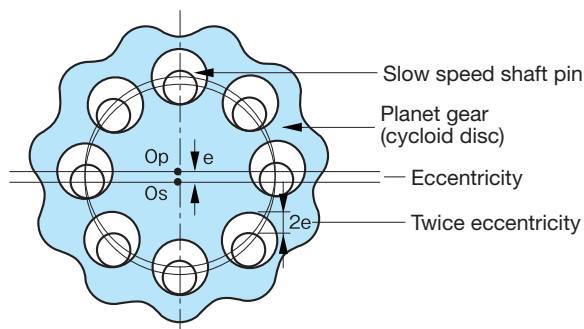
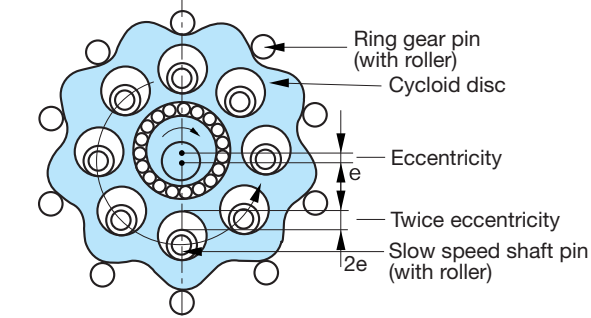

Fig. D-6 Combination of Planet-Sun Gears and Constant Speed Internal Gear



MEMO

Warranty

The scope of our warranty for our products is limited to the range of our manufacture.

Warranty (period and contents)

Warranty Period	The warranty period for the Products shall be 18 months after the commencement of delivery or 18 months after the shipment of the Products from the seller's works or 12 months from the Products coming into operation, whichever comes first.
Warranty Condition	<p>In the event that any problem or damage to the Product arises during the "Warranty Period" from defects in the Product whenever the Product is properly installed and combined with the Buyer,s equipment or machines, maintained as specified in the maintenance manual, and properly operated under the conditions described in the catalog or as otherwise agree upon in writing between the Seller and the Buyer or its customers ; the Seller will provide, at its sole discretion, appropriate repair or replacement of the Product without charge at a designated facility, except as stipulated in the "Warranty Exclusions" as described below.</p> <p>However, if the Product is installed or integrated into the Buyer,s equipment or machines, the Seller shall not reimburse the cost of : removal or re-installation of the Product or other incidental costs related thereto, any lost opportunity, any profit loss or other incidental or consequential losses or damages incurred by the Buyer or its customers.</p>
Warranty Exclusions	<p>Notwithstanding the above warranty, the warranty as set forth herein shall not apply to any problem or damage to the Product that is caused by :</p> <ol style="list-style-type: none"> 1. installation, connection, combination or integration of the Product in or to the other equipment or machine that is rendered by any person or entity other than the Seller ; 2. insufficient maintenance or improper operation by the Buyer or its customers, such that the Product is not maintained in accordance with the maintenance manual provided or designated by the Seller ; 3. improper use or operation of the Product by the Buyer or its customers that is not informed to the Seller, including, without limitation, the Buyer,s or its customers, operation of the Product not in conformity with the specifications, or use of lubricating oil in the Product that is not recommended by the Seller ; 4. any problem or damage on any equipment or machine to which the Product is installed, connected or combined or on any specifications particular to the Buyer or its customers ; 5. any changes, modifications, improvements or alterations to the Product or those functions that are rendered on the Product by any person or entity other than the Seller ; 6. any parts in the Product that are supplied or designated by the Buyer or its customers ; 7. earthquake, fire, flood, sea-breeze, gas, thunder, acts of God or any other reasons beyond the control of the Seller ; 8. normal wear and tear, or deterioration of the Product,s parts, such as bearings, oil-seals ; 9. any other troubles, problems or damage to the Product that are not attributable to the Seller.